



■ Vers. 009



■ Vers. 272+291+049



■ Vers. 003



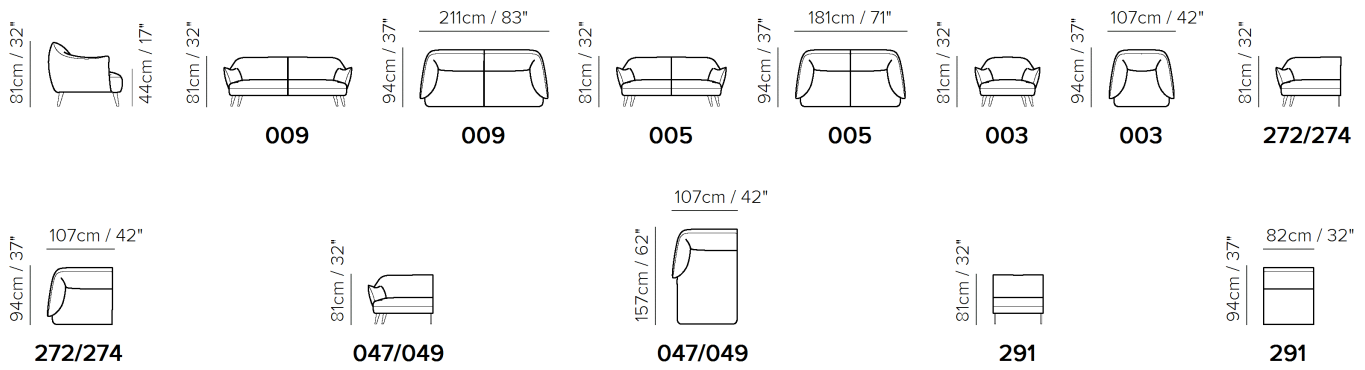

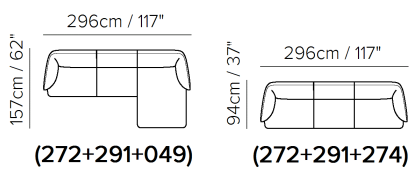

SCHEMATICS



COMPOSITION EXAMPLES



TECHNICAL INFORMATION

	COVERING	Leather <input checked="" type="checkbox"/>	Soft Cover <input checked="" type="checkbox"/>			
	LEGS	Plastic <input type="checkbox"/> Castors <input type="checkbox"/>	Metal <input checked="" type="checkbox"/>	Metal <input checked="" type="checkbox"/>	Wood <input type="checkbox"/>	Upholstered <input type="checkbox"/>
	FILLING	Arms <input type="checkbox"/> Fiber <input checked="" type="checkbox"/> Foam <input type="checkbox"/> Feather/Fiber Mix <input type="checkbox"/> Feather	Seat cushion <input type="checkbox"/> Fiber <input checked="" type="checkbox"/> Foam <input type="checkbox"/> Feather/Fiber Mix <input type="checkbox"/> Feather	Back cushion <input type="checkbox"/> Fiber <input checked="" type="checkbox"/> Foam <input type="checkbox"/> Feather/Fiber Mix <input type="checkbox"/> Feather		
	COMFORT	Standard Comfort <input checked="" type="checkbox"/>	Firm Comfort <input type="checkbox"/>			
	FUNCTION	Bed <input type="checkbox"/>	Electric motion <input type="checkbox"/>	Motion <input type="checkbox"/>	Recliner <input type="checkbox"/>	Sliding <input type="checkbox"/>
	OPTIONS	Nails <input type="checkbox"/>	Contrast Stitching <input type="checkbox"/>	Removable <input type="checkbox"/>		

NOTES

- LEATHER: Model available only in Top Grain leather
- In leather, model is available starting from cat. 15
- Model is available with contrast welt (or any another decorative detail such as a band under arm cushion) to be entered as second covering in the same category.
- FABRIC: In fabric contrast welt (or any another decorative detail such as a band under arm cushion) can be made either in same category fabric or in leather with any color of Le Mans (only).
- Tight Seat Cushion (the seat cushions of the models are fixed to the frame)
- Tight Back Cushion (the back cushions of the models are fixed to the frame)
- No Leather Side (the sectional pieces have the side covered with lining and not leather)
- Wood Frame
- Without Feet Assembled (the feet will be in a bag inside the package)
- Plastic Wrap (the model will be wrapped in a plastic bag)
- Second option versions have feet available in metal finishing 78 (Black Chrome) and 70 (brushed brass)
- Feet height 18,0 cm

NOTES
